

ELEVATION

1

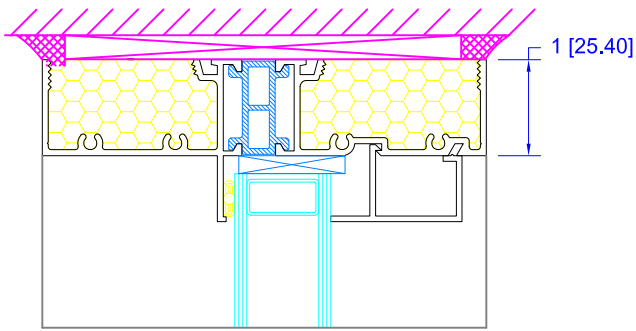

2

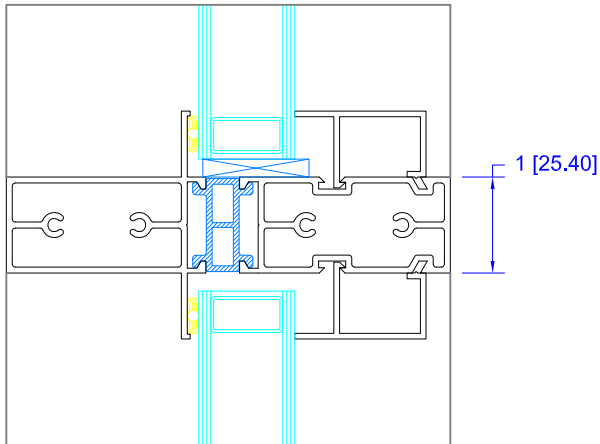

3

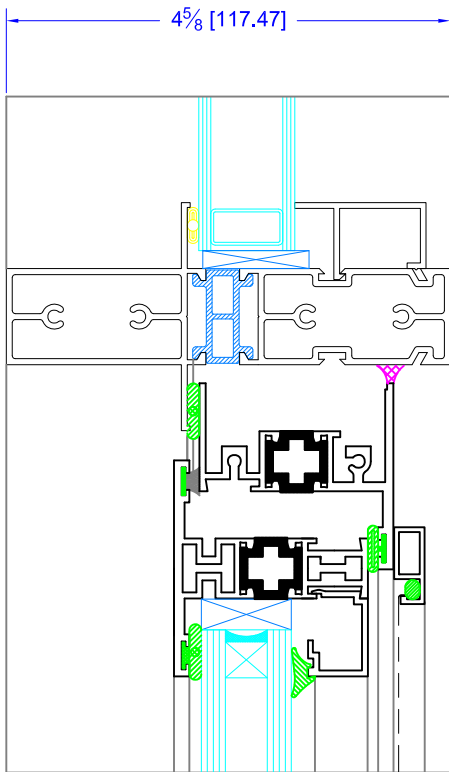

5

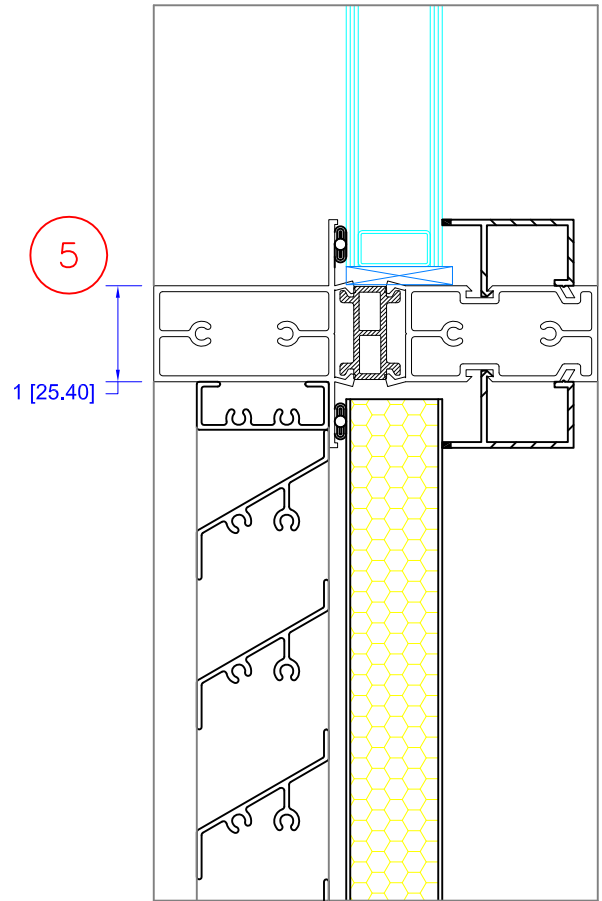

4

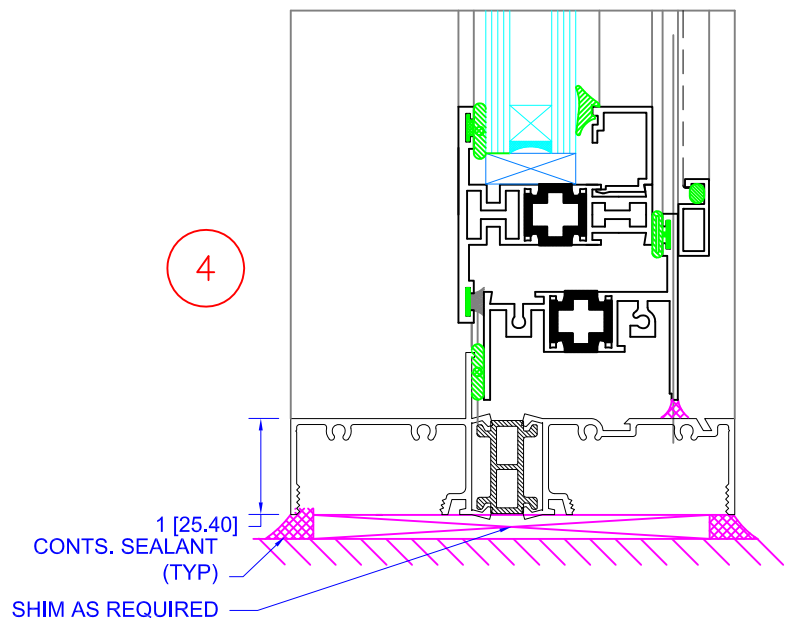

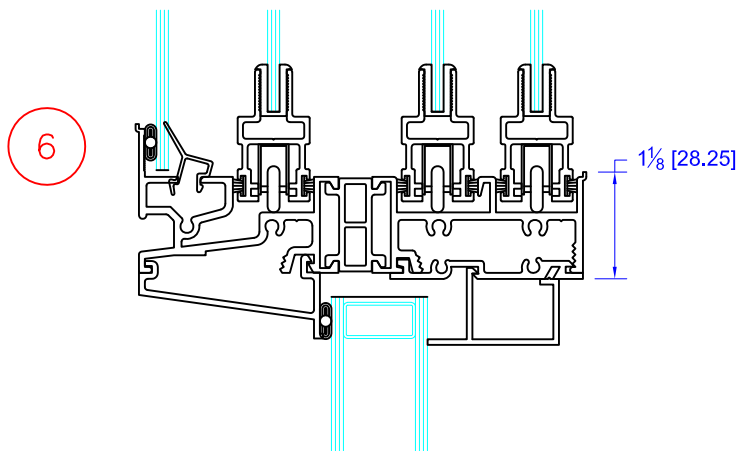
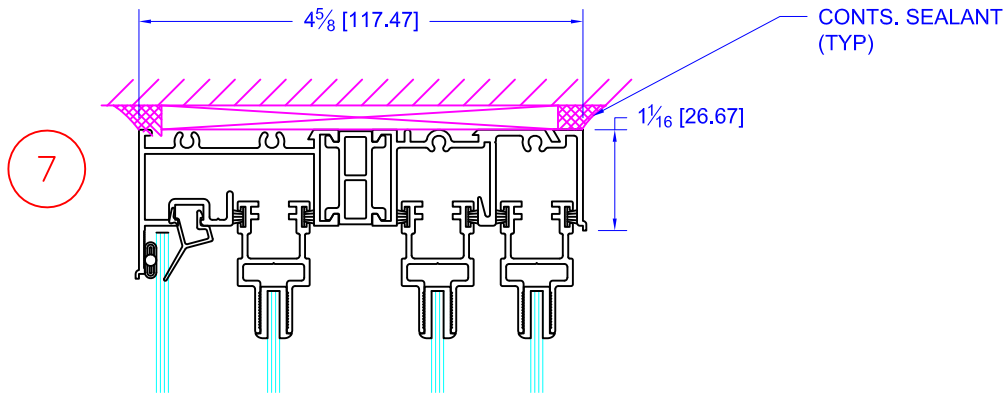

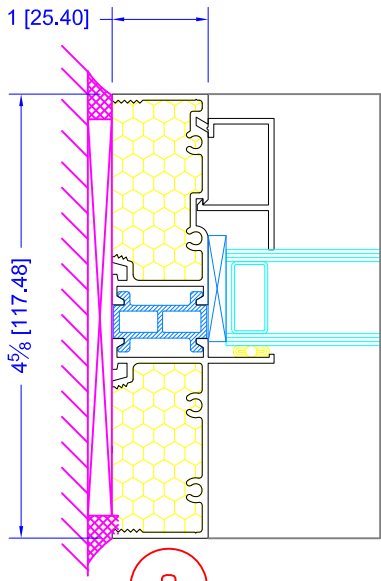

8

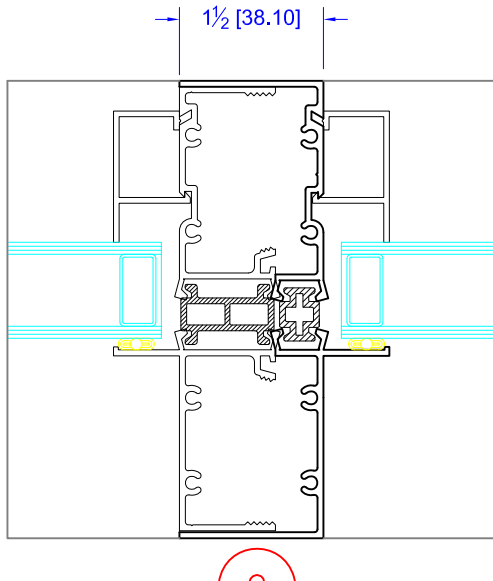

9

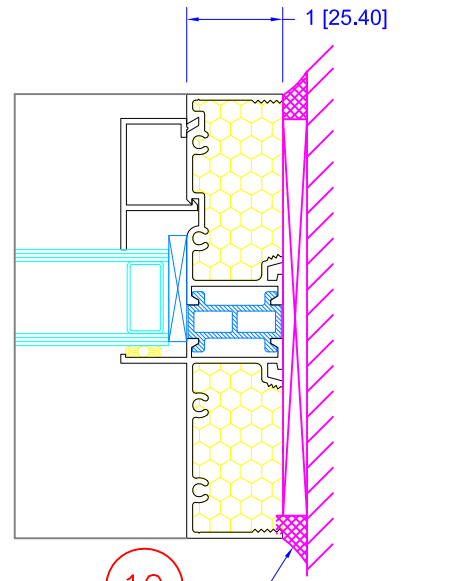

10

CONTS. SEALANT (TYP)

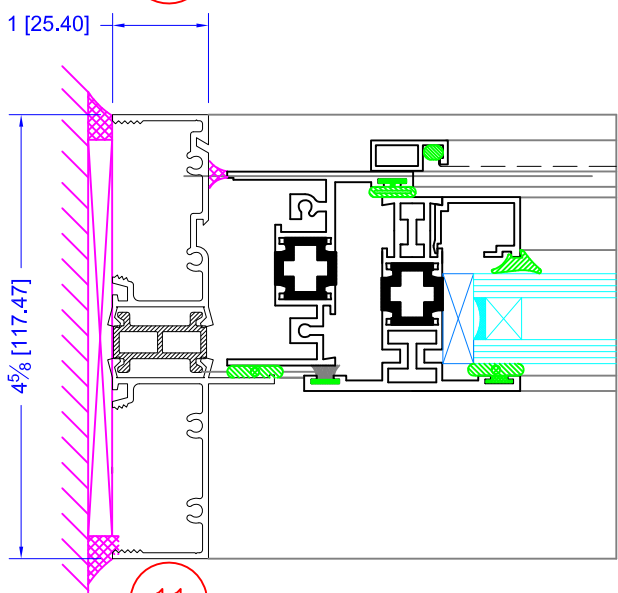

11

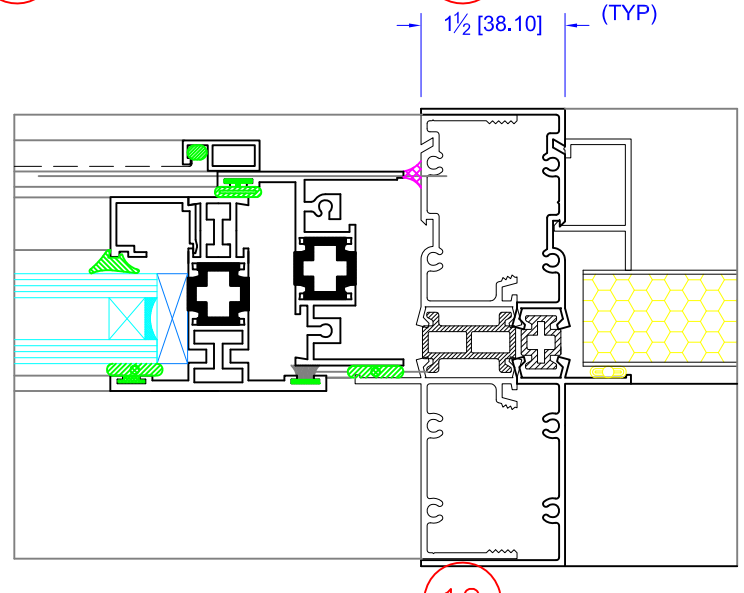

12

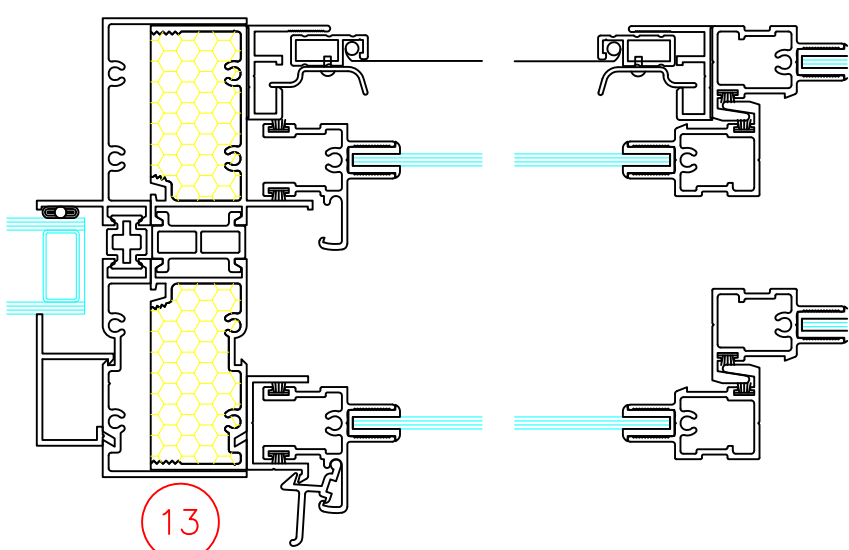

13

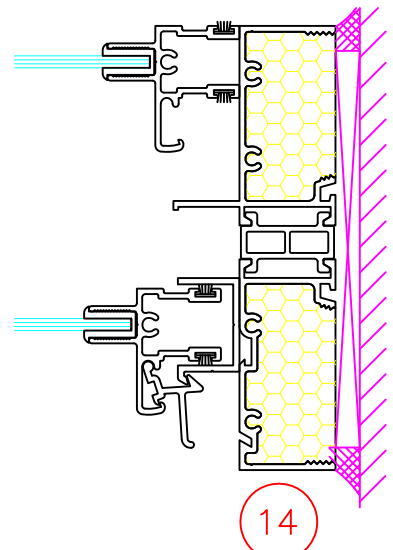

14